



# UNIVERSITÀ DI PARMA

## ARCHIVIO DELLA RICERCA

University of Parma Research Repository

Modeling simulation and experimental verification of an excavator hydraulic system - Load Sensing Flow Sharing Valve Model

This is the peer reviewed version of the following article:

*Original*

Modeling simulation and experimental verification of an excavator hydraulic system - Load Sensing Flow Sharing Valve Model / Casoli, Paolo; Anthony, Alvin; Ricco', Luca. - ELETTRONICO. - 1:1(2012), pp. 1-14. (Intervento presentato al convegno SAE 2012 Commercial Vehicle Engineering congress tenutosi a Rosemont, Illinois USA nel 2-3 ottobre 2012) [10.4271/2012-01-2042].

*Availability:*

This version is available at: 11381/2511444 since: 2015-12-14T14:00:25Z

*Publisher:*

SAE International

*Published*

DOI:10.4271/2012-01-2042

*Terms of use:*

Anyone can freely access the full text of works made available as "Open Access". Works made available

*Publisher copyright*

note finali coverpage

(Article begins on next page)



# Modeling Simulation and Experimental Verification of an Excavator Hydraulic System - Load Sensing Flow Sharing Valve Model

2012-01-2042

Published  
09/24/2012

Paolo Casoli, Alvin Anthony and Luca Ricco  
Universita di Parma

Copyright © 2012 SAE International

doi:[10.4271/2012-01-2042](https://doi.org/10.4271/2012-01-2042)

## ABSTRACT

This paper describes the results of a study focused on the mathematical modeling of an excavator hydraulic system. From the viewpoint of designing and tuning an efficient control system, the excavator is a very complex nonlinear plant. To design and tune such a complex control system an extremely good nonlinear model of the plant is necessary. The problem of modeling an excavator is considered in this paper; a nonlinear mathematical model of an excavator has been developed using the AMESim<sup>®</sup> modeling environment to replicate actual operating conditions. The excavator model is described by detailed models of the main pump, valve block and kinematic model. The objective of this research is to develop a complete simulation model of an excavator with the capability of reproducing the actual characteristics of the system. The model could then be used as a platform to facilitate the study of alternate control strategies towards energy efficient systems and new controller designs for HIL. The novelty in the modeling approach is that the detailed component models have been developed to replicate actual conditions while not being demanding on computational time. This has been achieved through a balance of semi-empirical models, while maintaining the flexibility of varying the gain characteristics of the components for enhancing system performance. The benefit of this model is it provides an advantage on computational time for complex system modeling while not compromising on the systems characteristics. Hence, this paper presents the developed model of a complete excavator system with detailed verification of individual components and preliminary results of a complete excavator system.

## KEYWORDS

Hydraulic Excavator, Variable Displacement Pump, Load Sensing, Flow Sharing Valve, Excavator Kinematics, Mathematical Model

## INTRODUCTION

In recent years the world economic situation has undergone a major change. This change has resulted in the collapse of well established markets and has affected a number of large infrastructure projects. Fortunately the recovery has come in and has brought with it added infrastructure needs. The renewed infrastructure projects have fueled a growth in the mobile equipment market. A major part of the infrastructure projects are from the BRICS (Brazil, Russia, India, China, South Africa) countries which have added substantial market potential. The product needs from these new markets are diverse from the established world markets.

These new markets have also added new customer needs in terms of product developments. All markets and users are not the same, thereby creating a demand on design teams to deliver products catering to varying demands and applications for the same mobile machinery. A principal target being that of achieving more efficient machinery. These efficiency targets can be sub-classified as - machine and operation efficiency. These various factors have an impact on both the design and market cost of the products. For a global manufacturer to compete in these markets they have to also be price sensitive to meet the needs of small fleet and individual owners. The needs of these markets add many constraints to product development thus requiring intelligent methods to prototype these machines.

One of the classic mobile machines that can be seen at a project site is that of an excavator. The excavator is versatile and offers a host of functions that can meet varying needs at a site. This can also be justified by the large production volumes of excavators. This paper will deal with the mathematical model development of an excavator to understand the interaction dynamics between the hydraulic system coupled with the structure. From the viewpoint of designing and tuning an efficient control system, an excavator is a very complex nonlinear plant. Towards realizing this objective a model comprising of hydraulic and kinematic systems have been developed. The need to model these systems is attributed to the inherently nonlinear hydraulic drive, used to achieve precise motion and power control. This choice of drive is attributed to the superior power density of hydraulic systems in comparison to electrical or mechanical drives; regrettably the poor energy efficiency of these systems is a major drawback. The need for energy efficient systems demands that this potent drive be self adjusting to meet actual load requirements [1,2,3]. A method of adjusting these systems to meet load requirements is by controlling the flow of a pump. In this context, variable - displacement axial piston pumps are often used, whereby the displacement of the pump can be varied by tilting a swash plate. The displacement of the pump's swash angle is achieved by means of an actuator which in turn receives its input from the load [4]. These types of pumps are known as load sensing pumps [5]. These load sensing signals are transferred from the load or actuator to the pump through a load sensing valve block. For this model development a load sensing flow sharing valve block has been used. This valve block is a mobile direction control valve used in Mobile applications, specifically for excavator controls. Flow sharing is a useful feature when global flow rate required by the various elements exceeds the maximum pump flow rate. This is an important feature in excavators, where several simultaneous motions are required and which provides proper control of the moving machine even under saturation conditions [2]. To reiterate the valve transmits the LS signal to the pump from the load. In the model presented in this paper a kinematic model of the excavator implements has been coupled to the model. This kinematic model would be used to subject the pump and valve to the varying forces that these hydraulic components would be subjected to in a real system. The dynamic forces of an excavation cycle are required for computing the load on the system and this would be obtained from the kinematic model of the excavator.

The above details provide a glimpse into the complexity of variable forces that a system would experience during an operating cycle for which the dynamic behavior of the flow sharing valve and variable displacement pump would be vital in tuning a system. Thus far, having described the objective of this research, the following sections will detail the modeling of the pump, valve and kinematics, validated results

of the pump and valve model as well as complete simulation of the system for the motion of an implement.

## PHYSICAL MODELING

### Pump Model

The pump model described in this paper is that of a load sensing variable displacement axial piston pump. This is a standard line production pump developed by Casappa® S.p.A. and belongs to the MVP series. As depicted in [figure 1](#), the pump model comprises of three sub-models: flow compensator, pressure compensator and the pump's flow characteristics. The pump model has been conceived as a grey box model, i.e. a model based on both insight into the system and experimental data as can be seen in [figure 2](#). The flow and pressure compensators have been modeled as white box models and that of the flow characteristics as a black box model. The grey box model of the pump correlates the control piston pressure and the system pressure to provide the equilibrium of forces that defines the swash plate angle. This model approach has been adopted to provide the manufacturer with the flexibility of selecting pumps with discrete maximum displacements to vary the complete system's gain.

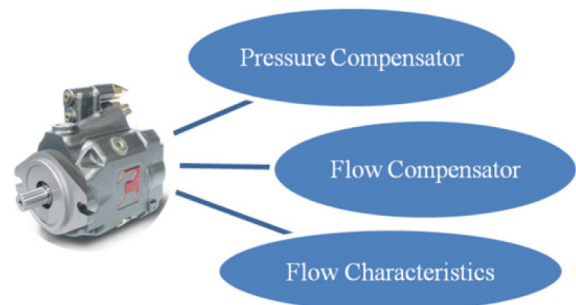


Figure 1. Model breakup of the MVP series, Load Sensing Variable Displacement Pump

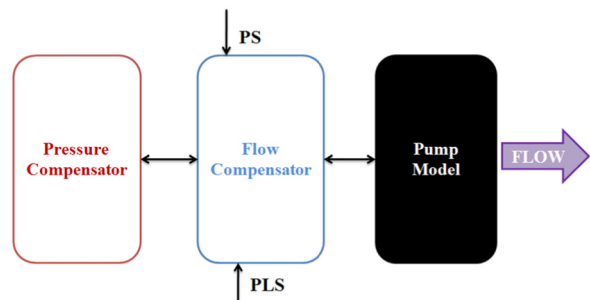


Figure 2. Gray Box modeling methodology

The mathematical models of the flow compensator, pressure compensator and flow characteristics have been developed using the AMESim® [6] simulation software able to describe the dynamics of the system.

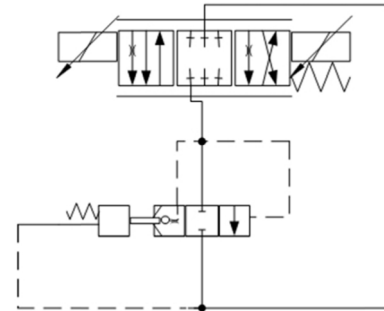
The flow compensator (FC) has the most important function of offsetting the pump displacement for a set preload by regulating the swash plate angle. This component has been modeled and verified in great detail [7]. The logic integrated in the FC is to compare the dominant load pressure (PLS) with the pump's output pressure (PS) to modulate the flow through the FC, hence regulating the pump's displacement. The objective of the FC is to maintain a fixed differential pressure across the control orifice accomplished by modulating the pump's flow. The function of the pressure compensator (PC) is that of a relief valve and its function is to limit the maximum pressure of the system,

A model of the pump's flow characteristics must permit the examination of dominant characteristics influencing the pump's behavior. In practice the accurate prediction of swash plate motion is the exclusive parameter required to represent an axial piston pump, as all pump components interact with the swash plate to determine its motion. The angle of the swash plate determines the stroke of the pumping pistons, the length of which dictates the flow characteristics. The prediction of the swash plate motion is made difficult due to the exciting forces imparted on the swash plate by the pumping pistons as well as the compressibility of the fluid in the control piston. The black box system identification was identified as the best model methodology to integrate this flexibility. This choice of modeling methodology was also attributed to the availability of an instrumented test facility and a large sample of experimental data. The black box model was realized by taking into account that the position of the swash plate could be determined by solely balancing the parameters of the control piston pressure and the system pressure. The control piston pressure is the pressure in the actuator that is used to displace the swash plate. The control piston receives its input from the flow/pressure compensator, depending on the state of the system. The system pressure is the pressure that acts on the swash plate to determine the forces on it. The forces acting on the swash plate affected by the system pressure comprises of the forces exerted by the pumping pistons exposed to the load and the internal friction forces. For details of the modeling of the pump please refer [5].

## Valve Model

This section describes the functioning and the modeling of the Walvoil® S.p.A. - DPX 100 Load Sensing Flow Sharing Valve Block. This valve block is a mobile direction control valve used in Mobile applications, specifically for excavator controls. It includes a downstream pressure compensator to incorporate the Load sensing flow sharing capabilities of the valve. The valve block has three mainly modes of operation: as a single user load sensing feedback valve, as a multi user load sensing flow sharing valve and as a piston check valve (to mechanically close the pressure compensator when the work port pressures are higher than the system pressure). In

the third mode of operation the operator can take advantage of the meter out notches on the valve spool to precisely control gravity assisted loads. The discussion of the functioning of the valve block is described in this section. Flow sharing is a useful feature when global flow rate required by the various elements exceeds the maximum pump flow rate. In this case the pump cannot maintain a constant pressure differential, whereby a pressure drop occurs across all the elements and causes a proportional flow rate reduction of all the elements. This feature is particularly such as excavators, where several simultaneous motions are required as it provides proper control of the moving machine even under saturation conditions. The DPX100 patented compensator maintains the margin pressure as a constant pressure drop across the spool metering area. The result is a flow to the work port dependent only on spool position. In case of flow saturation, the effective pressure drop across all spools is reduced equally. This results in proportional flow reduction at each section.



*Figure 3. ISO Schematic of Load Sensing Flow Sharing Valve DPX 100*

## Modeling of the Main Spool

The most important parameter in modeling the main spool (Figure 4 - MAIN SPOOL) is the study of the metering areas. The main spool is fairly complex with the pressure compensators orifice integral in the spool. One of the preliminary steps needed to create the model has been to study the flow areas - orifice openings. These flow paths are created by the metering grooves as the main spool is shifted to the left or the right, depending on the control requirement. The study of these flow paths would define the value of the minimum opening area for the oil inlet and exit for each position of the main spool, i.e geometric area. This creates the flow path for transition of the medium between different chambers within the valve. The calculation of the opening area is based entirely on the orifice geometry and does not take into account the curvature of the flow direction, which will define the effective area: the main spool semi circular metering grooves. When the main spool is shifted to the left or to the right, it opens an equivalent orifice area to allow the inlet pressure to the pressure compensator. A bidirectional spring is used to center the main spool in the unpowered position. The meter out notches are used to provide extra

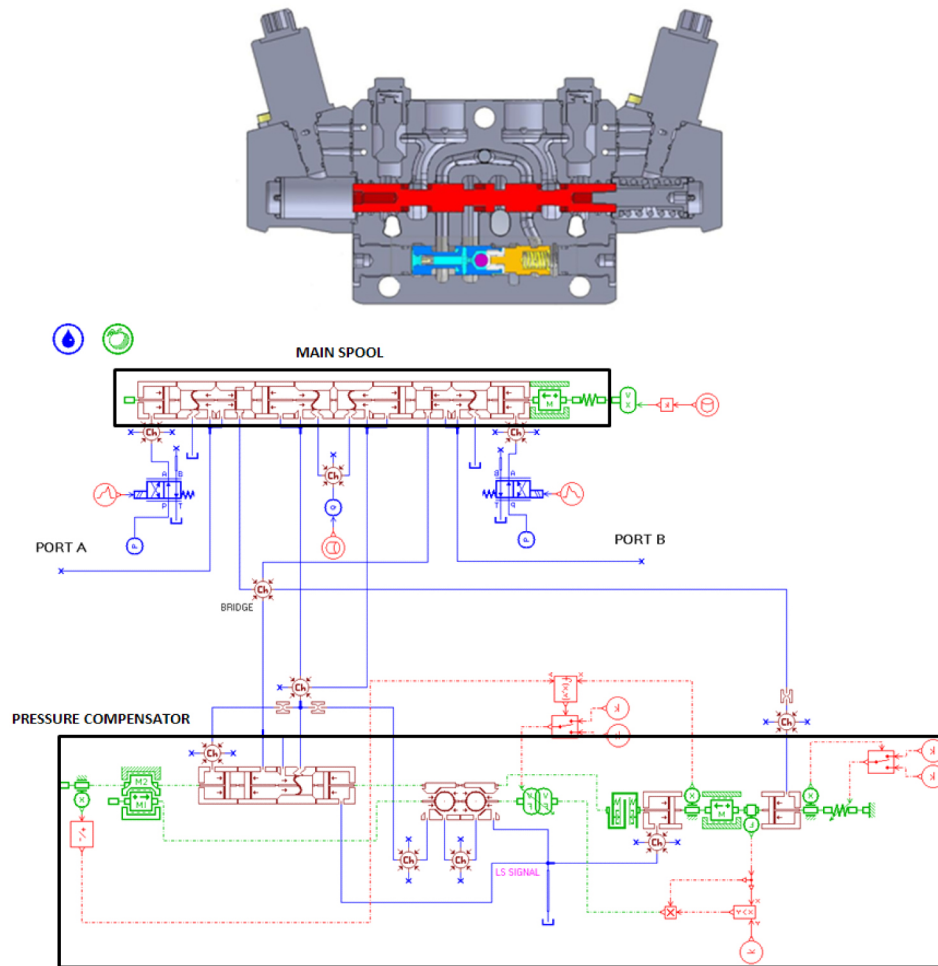


Figure 4. Valve Sectional view and AMESim<sup>®</sup> sketch model of the DPX100

controllability in terms of lowering the load in certain conditions when the pressure compensator is closed and does not allow the system pressure to see the load. This is achieved by accurately metering out the load flow to the tank line. This is a summary of the main spool geometry.

### Modeling of the Pressure Compensator

The pressure compensator is rather complex due to its geometry and several interdependent moving parts as depicted in figure 4 (PRESSURE COMPENSATOR). This component has very complex geometry that is used to determine its flow area. There a highlighted portion of figure 5 (PC) of the pressure compensator where it makes contact with the intermediate chamber to allow flow of the medium. After passing through the pressure compensator the medium flows into the bridge then feeds one of two user ports.

The figures 5 and 6 offer a detailed view of the complexity of the complete pressure compensator setup. The fluid enters the compensator from the intermediate chamber 1. The fluid passes through the sensing port 2 and offsets the Pressure Compensator which creates the initial displacement. simultaneously the fluid enters to the right of the pressure

compensator through the sensing hole 3 which houses a selector sphere and double tapered seat that is connected with the Load Sensing chamber.

The sub models of the pressure compensator comprises of simple transformer piston 4 and 5 to recreate the pressure forces of the fluid medium from the intermediate chamber to the bridge chamber. The module 6 reproduces the effect of metering in which the component creates a pressure drop the flow areas are read from an ASCII table, the element 7 and the force generated from the pressure existing in the chamber trying to divide the LS from the piston. The flow inside the compensator 4 and the restriction in the vicinity of the sphere 8 are reproduced with fixed orifice from the main valve. The asymmetric geometry of which the ball selector functions in is developed through the use of two transformers with a spherical body linked together in a cone. Both contain movable sleeves rigidly connected to the compensator. Element 9 which is a double mass element is used to reproduce the inertial effects and the limits which will not only offset but also displace the selector sphere inside its chamber. This element 10 is a body in body element which is used to describe the relative motions of the displacement of



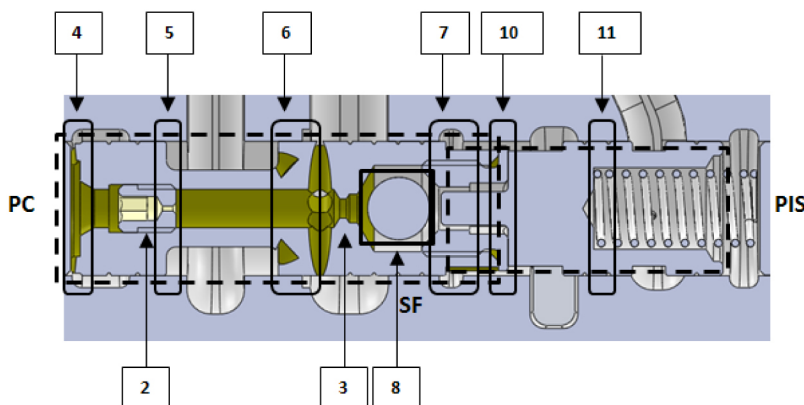


Figure 5. Pressure Compensator Sections

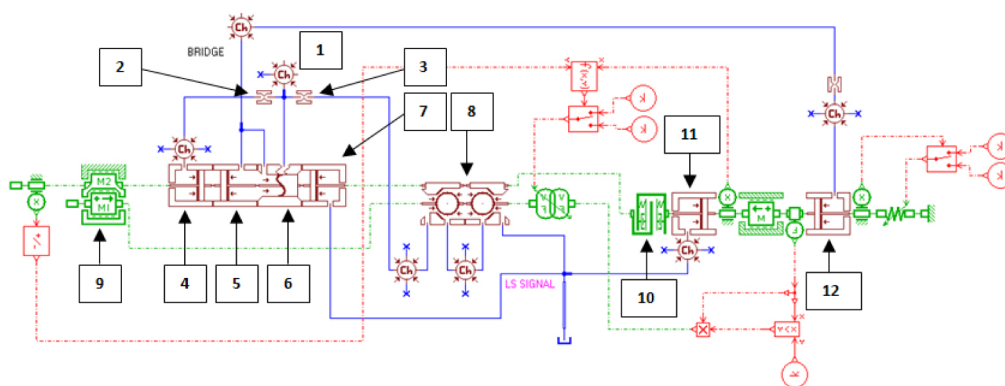


Figure 6. Pressure Compensator AMESim® Model

the pressure compensator with that of the selector sphere. To describe the piston check assembly, element 11 is a transformer element modeled as a piston and receives its control pressure from the LS chamber. Element 12 is a transformer element modeled as a piston and receives its control pressure from the bridge chamber.

The model of the pressure compensator, shown in figure 6, consists essentially of three moving parts shown in figure 5:

- The pressure compensator - PC
- The piston - PIS
- The selector sphere between the conical seats - SF.

The governing equations are described by the interaction between a fluid-dynamic model (FDM) and a mechanical-geometrical model (MGM). The FDM calculates the pressures inside the chambers and the flow rate between adjacent chambers, while the MGM calculates the forces acting on the spool and determines its dynamics and the flow areas.

The FDM is based on a lumped parameter framework. The pressure inside each control volume is assumed uniform and time dependent, and is determined by the pressure-rise rate equation:

$$\frac{dp_i}{dt} = \frac{\beta}{\rho_i} \frac{1}{V_i(x)} \left( \sum \dot{m} - \rho_i \frac{dV_i(x)}{dt} \right) \quad (1)$$

The model assumes a constant value of fluid temperature. The fluid density is evaluated as a function of pressure as described in [8]. The summation term represents the net mass flow rate entering or leaving the volume. This is obtained by considering the contribution of all orifices connected with the considered volume. The mass exchange occurring through the orifices is calculated using the generalized Bernoulli's equation under quasi-steady conditions, Eq. (2):

$$\dot{m} = \rho C_d A(x) \sqrt{\frac{2 |\Delta p|}{\rho}} \quad (2)$$

The user sets an appropriate saturated value for the coefficient of discharge of each connection, on the basis of experimental data or using values reported in literature, such as [9]; thereafter the instantaneous coefficient of discharge value is evaluated as a function of Reynolds number, to account for partially developed or fully turbulent conditions. Annular leakages past spool bodies have been evaluated using Eq. (3) as reported in [8]:

$$\dot{m} = \rho \frac{\pi R h^3}{6 \mu} \frac{|\Delta p|}{L} \quad (3)$$

The MGM calculates the instantaneous position and velocity of the spool using Newton's second law:

$$\sum_i F_i = ma \quad (4)$$

The forces acting on the spools, [figure 4](#), are: hydrostatic forces; spring force; friction forces; hydrodynamic forces. Static and dynamic friction forces are evaluated by use of the Karnopp friction model and considering the Stribeck effect; static and dynamic friction coefficients are assumed constant; the hydrodynamic forces are proportional to the orifice flow sectional area and pressure drop across the orifice, the model implements the equation:

$$F = 2 C_d A \Delta p \cos \theta \quad (5)$$

Where, the jet or flow angle  $\theta$  is affected by chamber geometry, orifice clearance and sharpness; for spool valves with a sharp edged orifice and no clearance between spool and sleeve,  $\theta$  can be assumed equal to  $69^\circ$  [10]. The other assumptions are that fluid inertia is neglected; springs are assumed linear.

## Excavator Dynamics

This section describes the modeling of the excavator kinematics which has been used to create the realistic forces on the hydraulic actuators. Considering the benefits of having the kinematic model integral with the hydraulic model, the linkage parameters were coupled to the hydraulic model using the Planar Mechanics library of AMESim® [11, 12]. This facilitates the understanding of dynamic loads on the hydraulic cylinder. The driving joint torques of the boom, arm and bucket are generated by the forces of the hydraulic ram actuators. The translational and rotational motions of these links are described by the dynamic model of the excavator system. The kinematic model has been incorporated as a lumped parameter model, which accounts for angular position, relative coordinates, distances between links, relative velocity, relative acceleration and the output forces. Joint forces of contact and stiffness, are also considered in the model. The equations of motion can be derived by applying the Euler-Lagrange equations to a Lagrangian energy function. The revolute pairs have been modeled as Lagrange multipliers and are calculated from the Baumgarte stabilization method applied to the constraint equations [13]. To develop a dynamics model of the manipulator, forward recursive equations similar to those applied in iterative Newton-Euler method were used to obtain kinematic relationships between the time rates of joint

variables and the generalized Cartesian velocities for the centroid of the links. Inertial effects of cylinders and their pistons are negligibly small compared to those of manipulator links, the hydraulic cylinders transmit axial forces only, the revolute joints have no friction, and all the links and supports are rigid.

## Overview of the Complete Model

A model has been developed for the simulation of vehicle behavior. [Figure 7](#) depicts the complete model with an ideal valve. As it can be seen the model thus far represents and deals with the upper carriage system. The model is represented in three sections, the first section comprising of the pump model, the second section of the ideal valve blocks and pressure feedback logic and the third section representing the rigid body linkage. As part of the present stage of model development, the pump and kinematics model have been linked together, using valve blocks and pressure compensated flow control valves with ideal characteristics. The pressures across all actuator ports have been compared to provide the maximum load at any instant of time to provide the LS pressure to the FC. The actuators in this model are linear actuators and have been modeled as components which include pressure dynamics in the volumes on either side of the piston, viscous friction, and leakage past the piston.

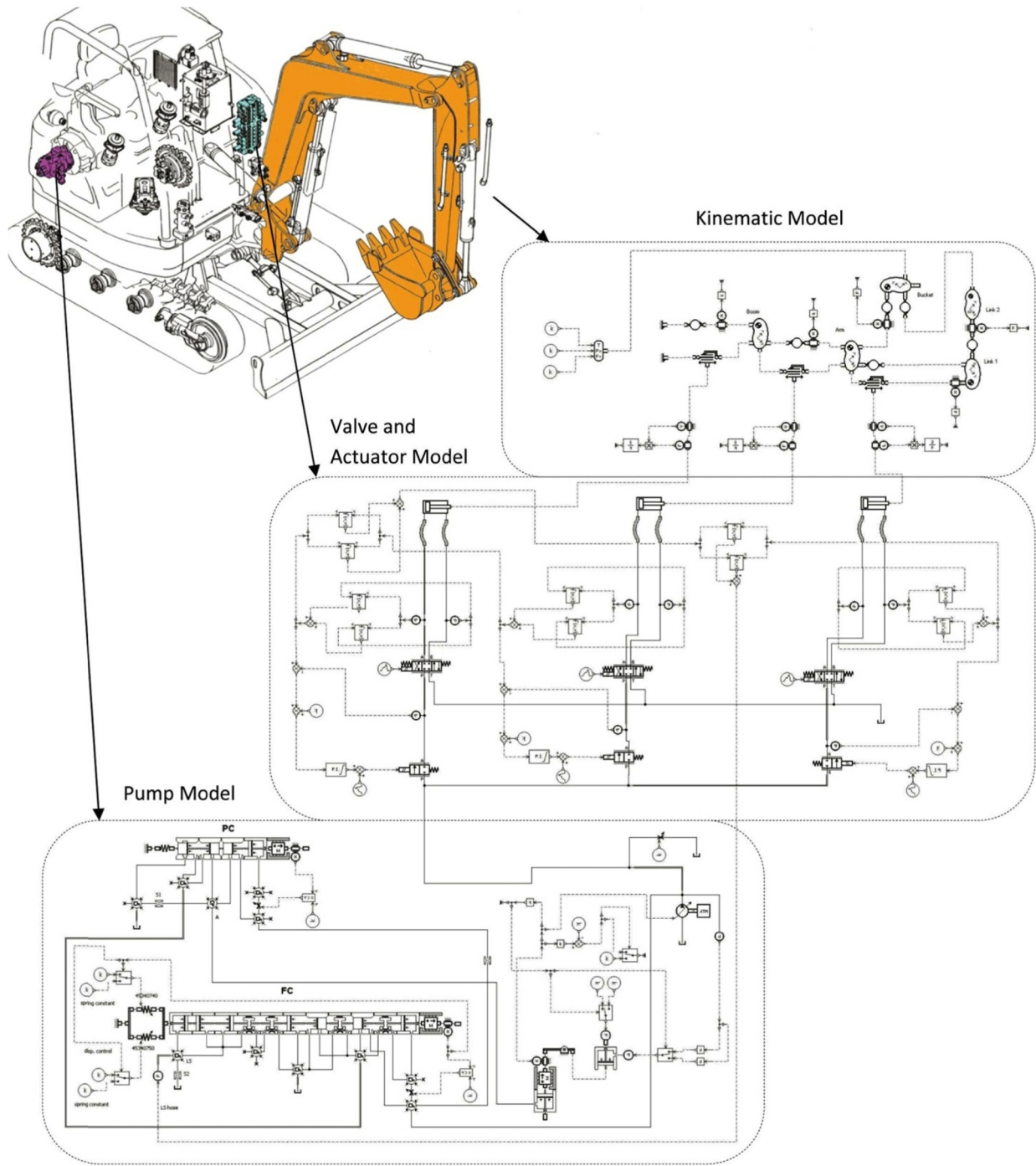
## EXPERIMENTAL SETUP

### Valve Experimental Test Setup

The [figure 8](#) represents the schematic of the test setup that was developed to test the functioning of the valve working as a single slice, in [Table 1](#) are reported the features of the sensors used.

The tests were carried out using the valve coupled with a variable displacement pump. This provides the added benefit of studying the pump's flow compensator as in a real system. This was executed by connecting the pump's load sensing line to the valve LS line. A flow meter was used at the inlet of the valve to measure the inlet flow and a pressure transducer to determine the inlet system pressure. The main spool was actuated by setting a pilot pressure of 35 bar with a gear pump, following which the current to the proportional flow control solenoids were altered to displace the main spool.

[Figure 9](#) illustrates a cross section of the valve along with the pressure mapping points and the mounting positions of the two LVDT's connected to the main spool and the pressure compensator.



**Figure 7. Overview of the Complete Model with ideal valve**



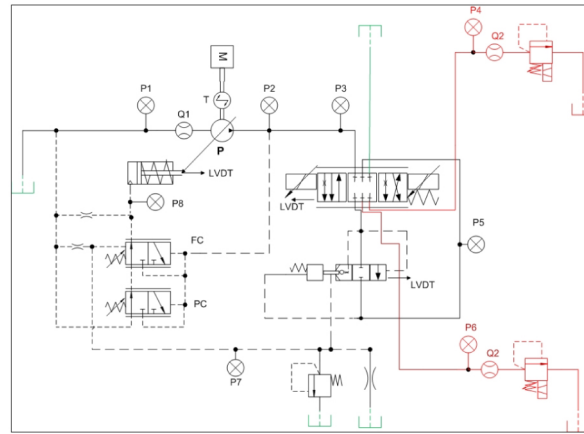


Figure 8. Test setup for Load Sensing Flow Sharing Valve

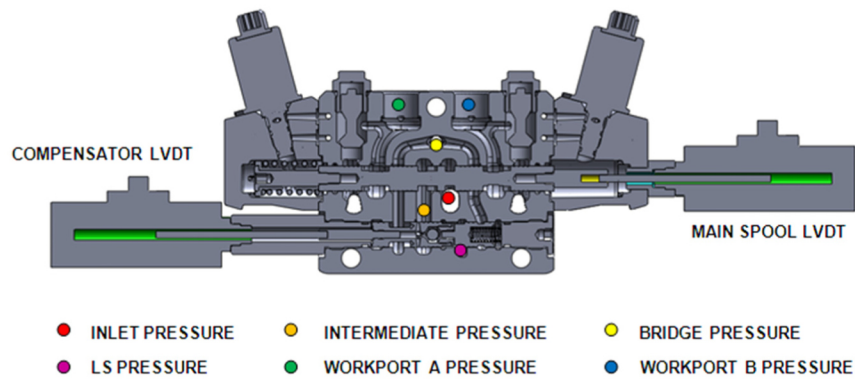


Figure 9. Valve with LVDT mounted and Pressure Mapping Points

Table 1. Features of sensors and main elements of the apparatus used in the present research

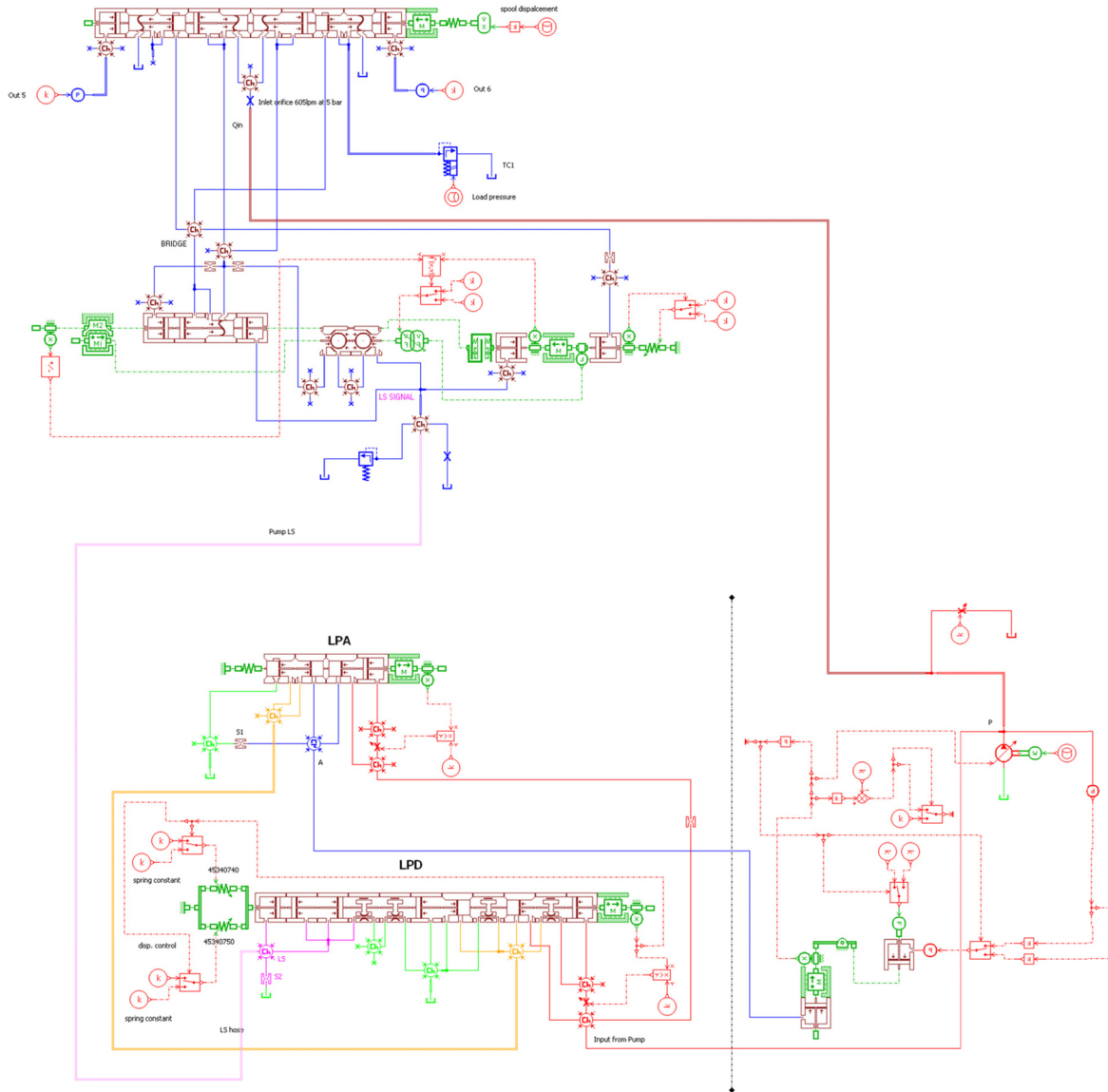
| Sensor  | Type                                     | Main features  |
|---------|--|--|
| M       | Prime mover                              | ABB®, 4-quadrant electric motor, 75 kW   |
| P       | Pump                                     | CASAPPA® MVP60, 84 cm <sup>3</sup> /r  |
| P1      | Strain gage                              | WIKA®, Scale: 0..40 bar, 0.25% FS accuracy                                       |
| P2 – P8 | Strain gage                              | WIKA®, Scale 0..400 bar, 0.25% FS accuracy                                       |
| Q2      | Flow meter                               | VSE® VS1, Scale 0.05..80 l/min, 0.3% measured value accuracy                     |
| T       | Torque/speed meter                       | HBM® T, Scale: 0..500 Nm, 12000 r/min Limit Velocity, 0.05 Accuracy Class        |
| Θ       | Incremental encoder                      | HEIDENHAIN® ERN120, 3600 imp./r, 4000 r/min Limit velocity, 1/20 period accuracy |
| LVDT    | Linear variable differential transformer | Magnet Schuz AVAX 015  |

## COMPARISON BETWEEN EXPERIMENTAL AND SIMULATION RESULTS FOR THE PUMP MODEL AND VALVE

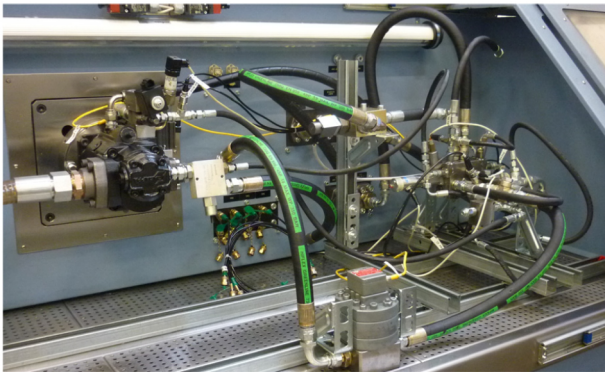
### Comparison of Results - Laboratory Testing of Pump Characteristics and Valve

Figure 10 depicts the AMESim® sketch of the system comprising of the pump and valve used to recreate the layout mounted on the test bench, as shown in figure 11.

The validation of the mathematical model was carried out by conducting a series of dynamic tests, one set of tests are represented in figures 12,13,14,15,16,17,18,19,20,21. The test conditions were such that a constant load of 100 bar was maintained at the load. The main spool's initial position was the center position with no flow in this condition. By increasing the proportional signal which controls the pilot solenoid the spool was moved to the full opening position. After few seconds the spool was returned to the initial condition.



**Figure 10.** AMESim<sup>®</sup> model of pump and valve



**Figure 11.** Test Bench Layout

Figure 12, 13, 14 and 15 describe the validation of the simulation pressures based on experimental pressures in the inlet chamber, intermediate chamber, bridge and LS chamber

pressure. The results show that there is a good relation between the experimental and simulation results in all the chambers of the valve.

Figures 16 and 17 describe the displacement and transient behavior of the pressure compensator. As can be seen in figure 16 there is a steady state error of less than 10% but this does not affect the pressures in the corresponding chambers. Moreover the transient behavior of the compensator is acceptable for the mathematical model developed.

Figures 17 and 18 describe the valve inlet flow characteristics generated by the pump model and the outlet flow characteristics from the valve.

Figure 19 describes the pump swash angle and in the first five second it's possible observe the initial pump's transient behavior.

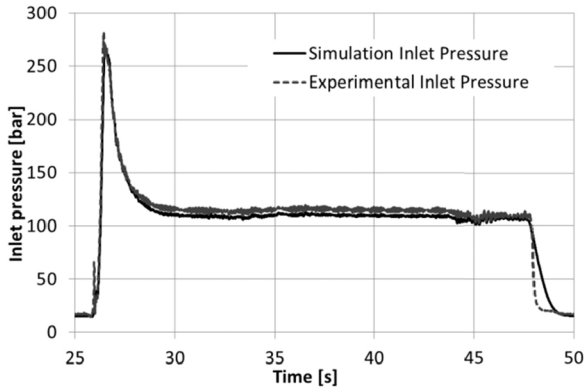


Figure 12. Inlet Pressure

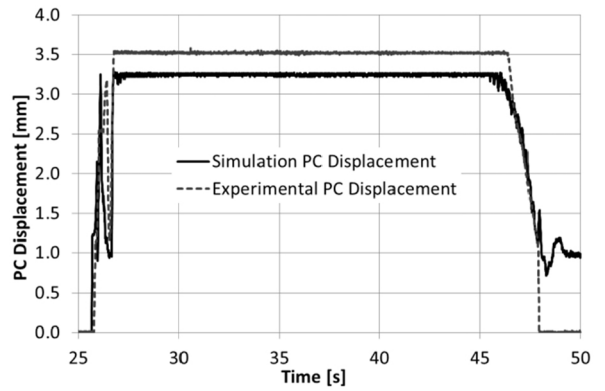


Figure 16. Pressure Compensator Displacement

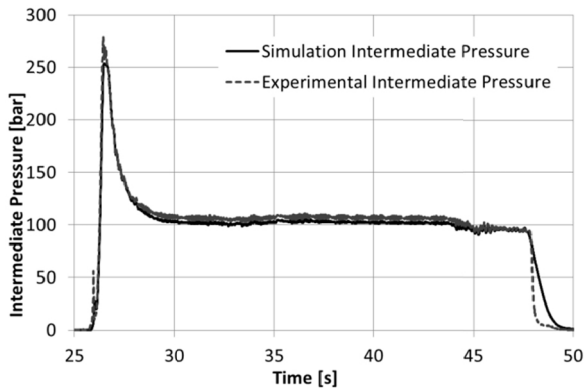


Figure 13. Intermediate Pressure

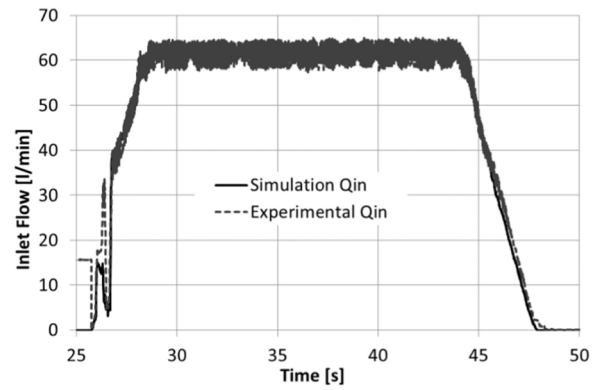


Figure 17. Inlet Flow from the Pump

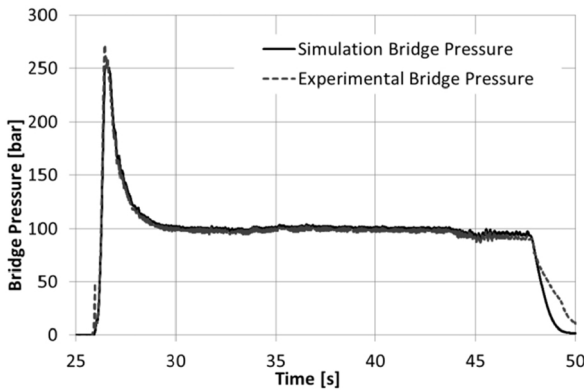


Figure 14. Bridge Pressure

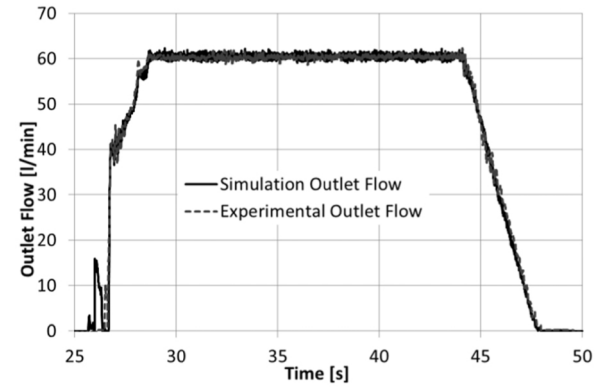


Figure 18. Valve Workport B Outlet Flow

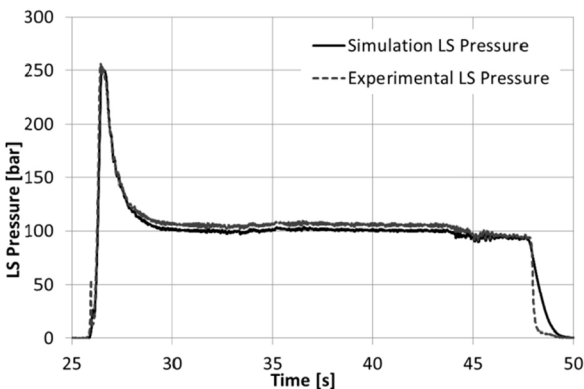


Figure 15. Load Sensing Pressure

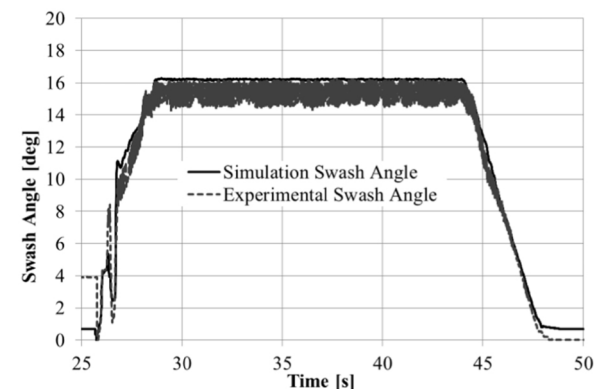
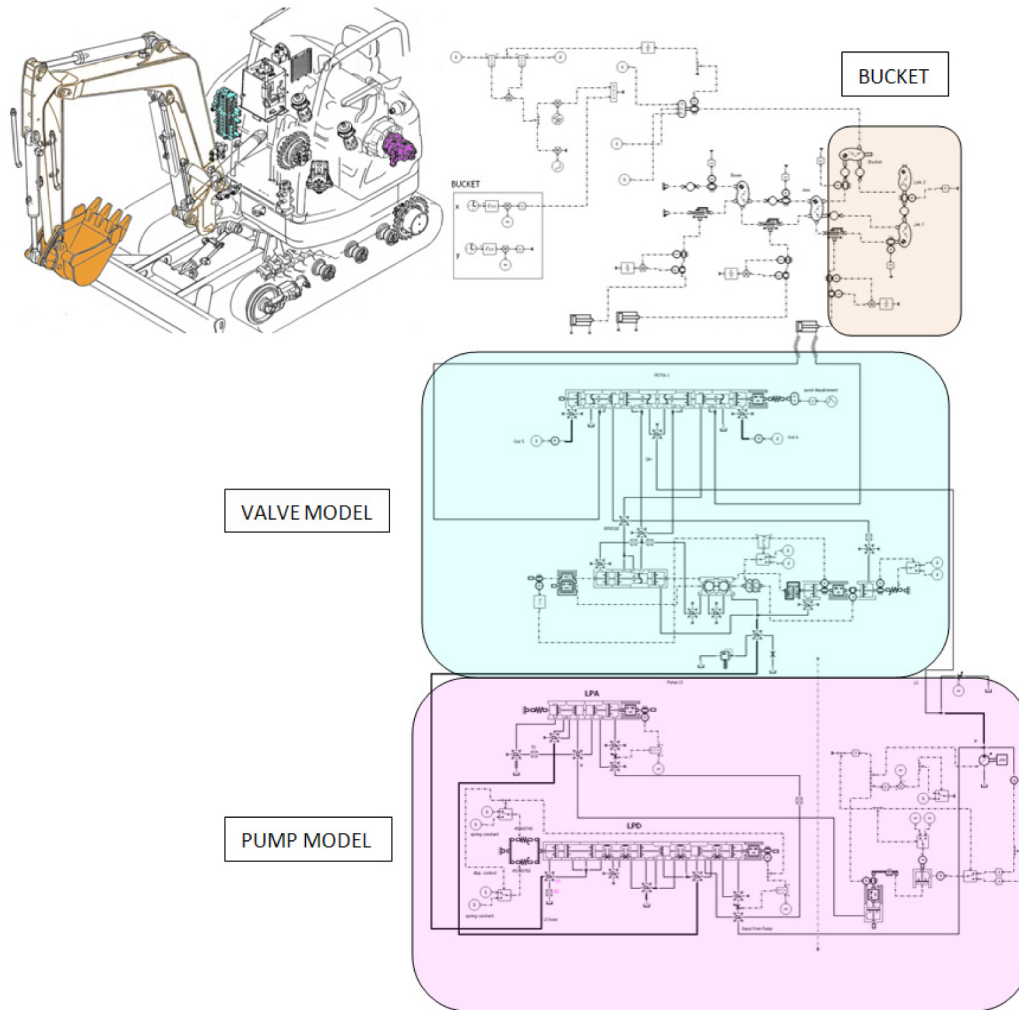


Figure 19. Pump Swash Angle



**Figure 20. Overview of the simulated model with the pump, valve and bucket**

These figures describe the capability of the mathematical model to recreate the transient and steady state behavior of the pump and valve, hence developing in the user confidence in the models capabilities. It can also be seen that a complete system can be studied as well as the intricacies in each part of the assembly.

## EXCAVATOR MODEL

### **Excavator Model: Bucket Cycle**

Based on the analysis of results presented in the previous section, it is evident that the pump and valve models are capable of reproducing actual conditions. Thus to demonstrate the model's capabilities the kinematics was included as illustrated in [figure 20](#). The complete system was subjected to a duty cycle as described in [Table 2](#). The time step and values from [Table 2](#) were used to control the valve opening for the bucket implement. The pump's maximum displacement in this simulation was 84 cm<sup>3</sup>/rev and the engine speed was set at 1000 r/min. The figures in this

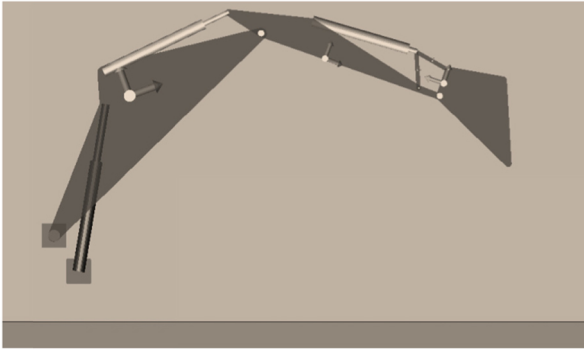
section provide the system developers an insight into the internal functioning of the pump and the valve. This information is vital for studying new control strategies or proposing improvements in the design of these components.

**Table 2. Duty cycle - Control Signals to Valve Block for Bucket Motion**

| <i>Implement Name</i> | <i>Time [s]</i> | <i>Valve Opening [%]</i> | <i>Actuator Action</i> |
|-----------------------|-----------------|--------------------------|------------------------|
|                       | 0 - 1           | 0                        | -                      |
| Bucket                | 1 - 2           | 100                      | Extension              |
|                       | 2 - 3           | 0                        | -                      |
|                       | 3 - 6           | 0 - 50                   | Retraction             |

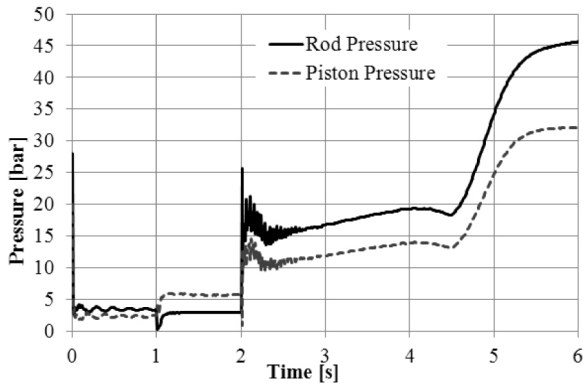
[Figure 21](#) describes the initial condition of the excavator in the simulation model, the reader is requested to bear in mind

that the arm and boom are fixed and the motion is only that of the bucket.



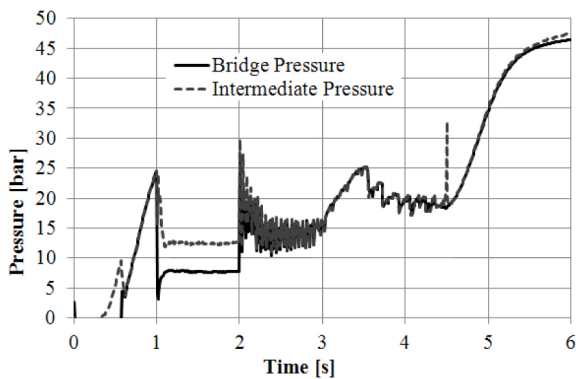
**Figure 21. Initial position of the Excavator**

Figure 22 describes the pressure in the bucket actuator (piston and rod chambers) during the bucket duty cycle.

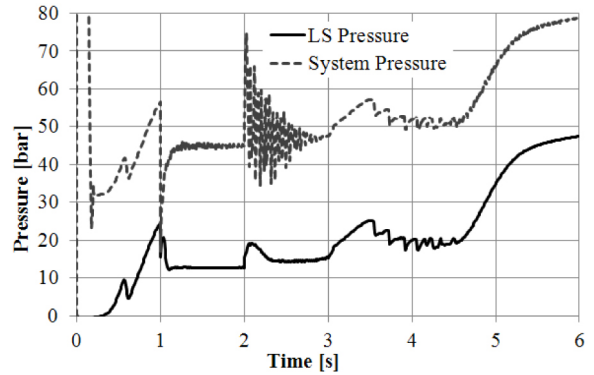


**Figure 22. Actuator Pressure**

Figure 23 - 24 describes the pressures across the valve, as it can be seen the system pressure follows the LS pressure signal (the flow compensator was set at 30 bar for this test, to replicate a particular manufacturer's specifications).

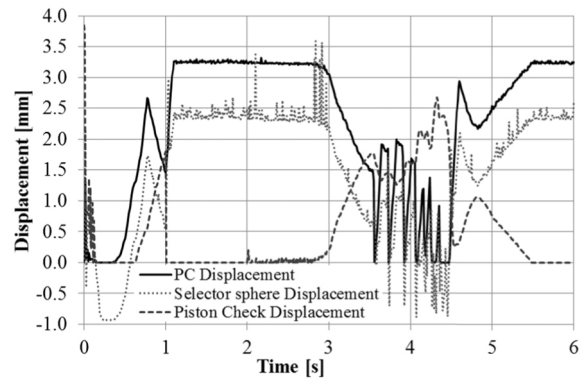


**Figure 23. Valve - Intermediate and Bridge Pressure**



**Figure 24. System Pressure and LS Pressure**

Figure 25 illustrates aspects very important for a valve manufacturer. This figure describes the instantaneous position of all three elements that comprise of the pressure compensator assembly. The transient behavior of each element in addition to the pressure characteristics from figures 23 and 24 can be used to make improvements to compensator design, for example by modifying flow areas or notch geometry etc.



**Figure 25. Pressure Compensator, Selector Sphere and Piston Check Displacement**

Figure 26 describes the instantaneous spool positions of the Pump's FC and PC. The FC provides a flow path through the spool when the displacement is greater than 3.90 mm and the PC when the spool is at 2.70 mm. In these spool positions, the pump's valves allow a flow through the spool which results in the pump's actuators being pressurized to change the swash angle of the pump [5].

Figure 27 describes the pump swash angle controlled by the flow across the FC and PC spools (the pump maximum flow rate is reached at 21 deg). Figures 25, 26 and 27 are vital to a pump manufacturer for tuning the pump's controllers or for modifying the pump's flow gain characteristics.



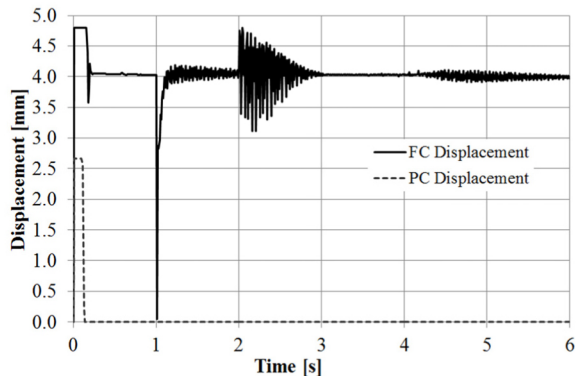


Figure 26. Pump Flow (FC) and Pressure Compensator (PC) Displacement

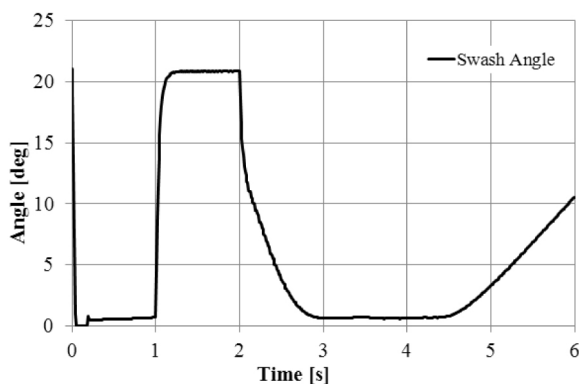


Figure 27. Pump Swash Angle

## CONCLUSIONS

The paper has presented an excavator hydraulic circuit model, focused on the control valve. A nonlinear mathematical model of an excavator has been developed using the AMESim<sup>®</sup> modeling environment to replicate actual operating conditions. The model is described by hydraulic models comprising of a load sensing pump, a flow sharing valve model and a 2D kinematic model to simulate the excavator's body elements. This approach has enabled the study of the dynamic behavior and interaction of the pump and valve with a completely developed kinematic model of the excavator. The detailed hydraulic model described has been that of the load sensing flow sharing valve block. This model has been modeled in great detail as it offers different levels of complexity in its functioning. The most complex function that had to be recreated was that of the interaction between the pressure compensator and the piston check valve, which offers a mechanical contact or a hydraulic contact situation. Creating this switching mechanism has offered a great deal of originality to the model development. The mathematical model of the valve has been validated against experimental results in different conditions. The pump and valve models and their verification as represented in this paper offer a great deal of confidence in the individual

models capabilities of recreating the functioning of an excavator. The last section of the paper provides an overall view of the hydraulic models capability coupled with the kinematics of the system. One single motion of the kinematics i.e, the movement of the bucket has been discussed. The results presented show the advantages that this model possess in aiding a pump and valve designers in analyzing/assessing the behavior of their components. Therefore the authors are confident to bring the study forward for future assessment of strategies aimed to improving the control of the system and the overall system efficiency.

## REFERENCES

1. Wu, D., Burton, R., Schoenau, G., Bitner, D. (2007), "Analysis of a Pressure -Compensated Flow Control Valve", ASME Journal of Dynamic Systems, Measurement and Control, March 2007. Vol.129, pp. 203-211.
2. Zimmerman, J., Ivantysynova, M. (2011) "Hybrid displacement controlled multi-actuators hydraulic systems". In The Twelfth Scandinavian International Conference on Fluid Power, May 18-20, 2011, Tampere, Finland. ISBN 978-952-15-2520-9.
3. Inderelst, Martin, Losse, Stephan, Sigro, Sebastian, Murrenhoff, Hurbertus (2011). "Energy efficient system layout for work hydraulics of excavators". In The Twelfth Scandinavian International Conference on Fluid Power, May 18-20, 2011, Tampere, Finland. ISBN 978-952-15-2520-9.
4. Ivantysyn, J., Ivantysynova, M., 2003, "Hydrostatic Pumps and Motors", Tech Books Int., New Delhi, India. ISBN:81-88305-08-1.
5. Casoli, P., Anthony, A., Rigosi, M., "Modeling of an Excavator System - Semi Empirical Hydraulic Model," *SAE Int. J. Commer. Veh.* 4(1):242-255, 2011, doi: [10.4271/2011-01-2278](https://doi.org/10.4271/2011-01-2278).
6. LMS Imagine - AMESim<sup>®</sup> Reference manual 2009
7. Casoli, Paolo, Anthony, Alvin, (2011) "Modeling of an Excavator - Pump Nonlinear Model and Structural Linkage/ Mechanical Model", Proc. of 12<sup>th</sup> Scandinavian International Conference on Fluid Power, pp. 25-40, Vol. 3, May 18-20 2011, Tampere, Finland. ISBN 978-952-15-2520-9.
8. Merrit, H.E. (1967) "Hydraulic Control Systems", Wiley, New York.
9. McCloy, D., Martin, H. M. (1973). "The control of Fluid Power", Longman, London, 1973. ISBN 0-85312-135-4.
10. Blakburn, J. F., Reethof, G. & Shearer, J. L. (1966) "Fluid Power Control". USA: MIT Press, 1966. ISBN 0262520044.
11. Casoli, P., Vacca, A., Anthony, A., Berta, G.L. (2010) "Numerical and Experimental Analysis of the Hydraulic

Circuit for the Rear Hitch Control in Agricultural Tractors”  
7<sup>th</sup> International Fluid Power Conference, (pp. 51-63, vol. 1)  
Aachen, 22-24/03 2010, ISBN 978-3-940565-90-7

12. Anthony, Alvin, Casoli, Paolo, Vacca, Andrea. (2010)  
“Analysis of a tractor rear hitch control system” Proc. Of 6<sup>th</sup>  
FPNI-PhD Symposium West Lafayette, 15-19 June 2010, pp.  
589-602. FPNI Fluid Power Net Publications, 2010. ISBN:  
1-932739-15-7.

13. Lin, Shih-Tin. (2002) “Stabilization of Baumgarte's”  
Method Using the Runge-Kutta Approach, ASME Journal of  
Mechanical Design, vol. 124, n.4, pp. 633-641. December  
2002.

## **CONTACT INFORMATION**

Paolo Casoli  
[paolo.casoli@unipr.it](mailto:paolo.casoli@unipr.it)

Alvin Anthony  
[alvinanthony7@gmail.com](mailto:alvinanthony7@gmail.com)

## **ACKNOWLEDGMENTS**

The authors would like to acknowledge the active support of  
this research by Casappa<sup>®</sup> S.p.A. and Walvoil<sup>®</sup> S.p.A.,  
ITALY.

## **DEFINITIONS**

*A* - flow area  
*a* - acceleration  
*c<sub>d</sub>* - discharge  
*F* - coefficient force  
*h* - gap height  
*i* - volume index  
*m* - mass  
*ṁ* - mass flow rate  
*P* - Pressure  
*P<sub>c</sub>* - Control Piston Pressure  
*P<sub>s</sub>* - System Pressure  
*Q<sub>l</sub>* - Leakage Flow  
*Q<sub>s</sub>* - Load Flow  
*R* - Radius  
*L* - length of the leakage  
*V* - Volume  
*t* - Time

### **Greek Letters**

*β* - bulk modulus  
*μ* - dynamic viscosity  
*ρ* - density

### **Acronyms**

**FC** - Flow compensator  
**PC** - Pressure compensator  
**PS** - System Pressure  
**PLS** - Load Sensed Pressure

---

The Engineering Meetings Board has approved this paper for publication. It has  
successfully completed SAE's peer review process under the supervision of the session  
organizer. This process requires a minimum of three (3) reviews by industry experts.

All rights reserved. No part of this publication may be reproduced, stored in a  
retrieval system, or transmitted, in any form or by any means, electronic, mechanical,  
photocopying, recording, or otherwise, without the prior written permission of SAE.

ISSN 0148-7191

Positions and opinions advanced in this paper are those of the author(s) and not  
necessarily those of SAE. The author is solely responsible for the content of the paper.

**SAE Customer Service:**  
Tel: 877-606-7323 (inside USA and Canada)  
Tel: 724-776-4970 (outside USA)  
Fax: 724-776-0790  
Email: [CustomerService@sae.org](mailto:CustomerService@sae.org)  
**SAE Web Address:** <http://www.sae.org>  
**Printed in USA**